

Compressed air laboratory stirrers PLR 28 model series

General specifications

- All-stainless steel housing
- Operating pressure 3-6 bar
- Air consumption 260 L/min. at 6 bar
- Clockwise rotation
- ATEX certification



Basic models include

- Continuously adjustable speed control valve
- Support arm Ø 14 mm
- Plug-in connector for DN 5

Required accessories connection coupling type VK 10 not included.



Type	PLR 28	PLR 28 T	PLR 28 GA
Power output	200 Watt	200 Watt	200 Watt
Volume	30 L	30 L	40 L
Viscosity	100000 mPas	100000 mPas	100000 mPas
Torque	10.4 Nm	10.4 Nm	10.4 Nm
No-load speed	580 rpm	550 rpm	450 rpm
Minimum operation speed	100 rpm	100 rpm	100 rpm
ATEX	Ex II 2G Ex h IIC T5 Gb	Ex II 2G Ex h IIC T5 Gb	Ex II 2G Ex h IIC T5 Gb
Code-No.	40 26446 00364 7	40 26446 00365 4	40 26446 00483 5

Viscosity data to be considered as guidelines. All technical data pertaining to 6 bar.

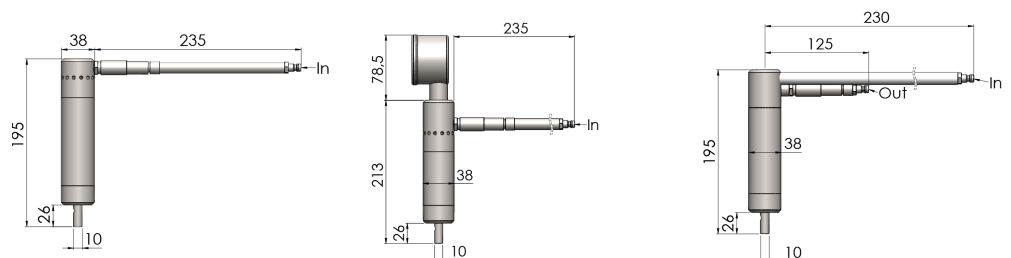

All dimensions in mm.

Standard design

Used compressed air can escape freely via exhaust air holes on the housing.
No additional connections for an exhaust air duct are required.



T design

The T models are equipped with an analogue speed display and simplify reproducible stirring processes with the same speed.

Speed range

 Low to medium

Types of mixing

-  Homogenising
-  Heat exchange
-  Suspending



PLR 28 T GA

PMR 28 GA

PMR 28T GA

200 Watt	200 Watt	200 Watt
40 L	40 L	40 L
100000 mPas	100000 mPas	100000 mPas
10.4 Nm	10.4 Nm	10.4 Nm
400 rpm	500 rpm	500 rpm
100 rpm	100 rpm	100 rpm
Ex II 2G Ex h IIC T5 Gb	Ex II 2G Ex h IIC T5 Gb	Ex II 2G Ex h IIC T5 Gb
40 26446 00488 0	40 26446 00771 3	40 26446 00773 7

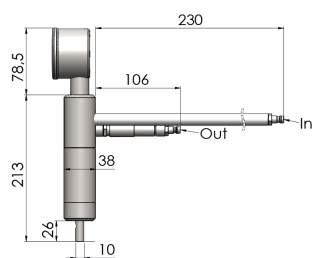

All dimensions in mm.

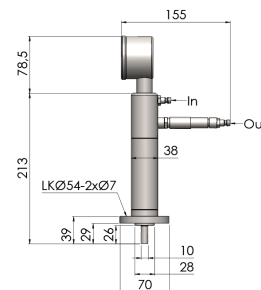
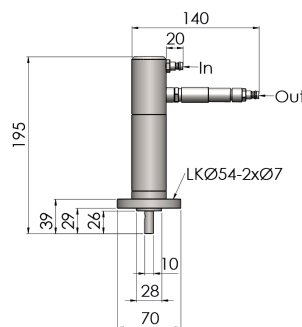

GA design

GA models feature a separate outlet connection for ducting the exhaust air which leads to improved performance at low speed and results in reduced noise levels. Discharging the exhaust air also enables the use in clean rooms.